



This manual is for reference and historical purposes, all rights reserved.

This page is copyright© by M. Butkus, NJ.

This page may not be sold or distributed without the expressed permission of the producer

I have no connection with any camera company

On-line camera manual library

This is the full text and images from the manual. This may take 3 full minutes for the PDF file to download.

If you find this manual useful, how about a donation of \$3 to: M. Butkus, 29 Lake Ave., High Bridge, NJ 08829-1701 and send your e-mail address so I can thank you. Most other places would charge you \$7.50 for a electronic copy or \$18.00 for a hard to read Xerox copy.

This will allow me to continue to buy new manuals and pay their shipping costs.

It'll make you feel better, won't it?

**If you use Pay Pal or wish to use your credit card,
click on the secure site on my main page.**

Canon

EOS REBEL S

EOS REBEL



English Edition
INSTRUCTIONS **E**

Thank you for selecting this Canon product.

It is important to read these instructions carefully before using your camera. The instructions consist of the following four sections:

I. PREPARATIONS FOR TAKING PHOTOGRAPHS

An explanation of the preparations you should carry out before beginning to take photographs.

II. TAKING PHOTOGRAPHS

An explanation of the basic ways of taking photographs.

III. TAKING DIFFERENT KINDS OF SHOTS





An explanation of different ways of taking photographs using the camera's various functions.

IV. OTHER INFORMATION

An explanation of the basic needs for photography and an introduction to some of the accessories that are available.

After reading the instructions on how to use your camera, you will find the information in this section useful to refer back to once you begin using the camera.

Main Features

1. This is the lightest and most compact single lens reflex (SLR) camera in the EOS range (as of September 1993).
 2. A wide autofocus frame, allowing free composition of your photographs.
 3. A simple dial operation which allows you to take photographs exactly as you see them in the image zone.
 4. Silent mechanisms ensuring quiet operation.
- Your new EOS camera can be used with any Canon EF lens. These instructions include an explanation of how to attach EF lenses.
 - The  symbol in this instruction book indicates useful hints when using the camera. The  symbol indicates situations where care should be taken to avoid possible problems.
 - This instruction manual is for use with both the Rebel X S and the Rebel X. However, instructions marked with an  are applicable only to the Rebel X S model (with built-in flash). For more information regarding the  mark, see page 4.



IMPORTANT INFORMATION

This camera will give optimum performance together with specially designed Canon EF lenses, flash units and other Canon brand accessories. It is possible that the use of incompatible lenses or other accessories may result in unsatisfactory performance or damage to your camera. We therefore suggest the use of Canon EF lenses and accessories. Damage to your Canon camera as a result of malfunction or improper connections caused by the use of incompatible products may void its warranty.

I. PREPARATIONS FOR TAKING PHOTOGRAPHS

II. TAKING PHOTOGRAPHS

III. TAKING DIFFERENT KINDS OF SHOTS

IV. OTHER INFORMATION

Precautions.....	4	External LCD Panel.....	9
Taking Photographs Straight Away.....	5	Viewfinder/Internal Information Display.....	9
Nomenclature.....	7	Command Dial.....	10
Attaching the Strap.....	11	How to Attach and Remove Lenses.....	13
Battery Loading and Checking Battery Level.....	11	Shutter Button and Autofocus.....	14
		Loading and Removing Film.....	15
Taking Photographs on the Full Automatic Mode (Q).....	17	Taking Photographs in Portrait Mode (👤).....	21
S The AF Auxiliary Light Emitter.....	18	Taking Photographs in Landscape Mode. (🏞).....	22
S Automatic Flash.....	19	Taking Photographs in Close-up Mode (👤).....	23
S Red-eye Reduction when Using the Flash.....	19	Taking Photographs in Sports Mode (🏃).....	24
Focussing on Subjects at the Edge of the Viewfinder.....	20		
Taking Photographs on the Program AE Settings (P).....	25	Partial Metering.....	39
Program Shift.....	26	Flash Photography with the Speedlite 200E.....	40
Six-second Timer.....	26	Exposure Compensation.....	41
Shutter-priority AE Settings (Tv).....	27	Bulb (Long Exposure) Photography.....	43
Aperture-priority AE Settings (Av).....	29	Multiple-exposure Photography.....	44
Manual Exposure Settings (M).....	31	Taking Pictures Using the Self-timer.....	46
Depth-of-field AE Settings (A-DEP).....	33	Changing the Film Speed Setting.....	47
Flash Photography with the Built-in Flash (Rebel X S only) (🔦).....	35	Shutting off the Beeper after Focussing.....	48
Setting the Red-eye Reduction Function.....	36	Removing Film before the End of the Roll.....	49
Taking Night-time Shots of People.....	37		
Basic Photographic Terms.....	50	AF Mode and Film Winding.....	55
Shutter Speed.....	50	Main Accessories.....	56
Aperture Value.....	50	Canon Speedlite Flashes.....	56
Film Speed (ISO Number).....	51	Remote Switch RS-60E3.....	56
Depth-of-field.....	51	Eye-piece Extender EP-EX15.....	56
Troubleshooting Tips.....	52	Grip GR-80TP.....	57
What to Do If the Exposure Meter on the LCD Panel Blinks.....	53	Camera Case.....	57
List of Functions that can be Used Together.....	54	Dioptic Adjustment Lenses.....	57
		Camera Care.....	58
		Table of Main Specifications.....	60

- 1) **This camera is not resistant to water** and should not be used outdoors in snow or rain. If accidentally dropped in water, contact an authorized Canon service facility. Keep the camera out of salt spray and protect it from excessive humidity. If used at the beach, clean it thoroughly afterward with a dry cloth.
- 2) Do not attempt to disassemble the camera yourself. Always take it to an authorized Canon service facility for repair.
- 3) Remove the battery if you do not expect to use the camera for about three weeks or longer.
- 4) When storing the camera, wrap it in a clean, soft cloth and place it in a cool, dry, dust-free place. Be sure to keep the camera out of direct sunlight, and away from “hot spots” such as the trunk or rear window shelf of a car. Avoid places where moth balls are used, and in extreme humidity, use a desiccant.
- 5) Carefully check the camera’s operation after lengthy storage.
- 6) The battery may explode or cause burns if disassembled, recharged, shorted, exposed to high temperatures, or disposed of in fire.
- 7) Film passing through X-ray examinations at airports may be exposed and ruined even if loaded in the camera. Request a hand-checked inspection to avoid damage.
- 8) Aerosol spray dust removers are not recommended for the shutter curtain.
- 9) Condensation is a problem when bringing cold equipment into a warm room. If the autofocus optics cloud over, accuracy may be seriously affected. Before entering a warm room, put equipment in a plastic bag so that condensation forms on the outside of the bag.
- 10) Color reproduction may be adversely affected if film is left in the camera for a long time. Always develop exposed film promptly.
 - Please see page 58 for camera care information.

- Meaning of the **S** mark in this instruction book
 - S** Indicates functions available only on the Rebel X S.
 - Indicates Rebel X S functions which are also available on the Rebel X with an external flash.

Taking Photographs Straight Away

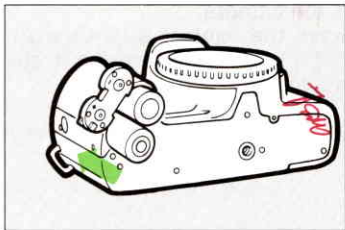

1. Load the batteries.
Insert two lithium batteries (CR123A/DL123A) into the camera as indicated.

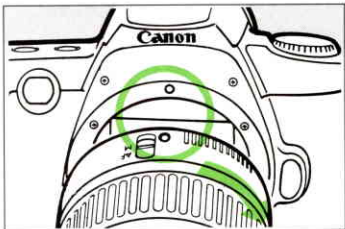

2. Attach the lens.
Align the red marks on the camera and lens, and turn the lens clockwise until it stops and locks with a click.

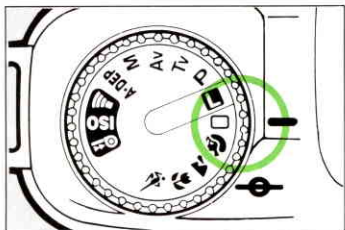

3. Set the command dial to .

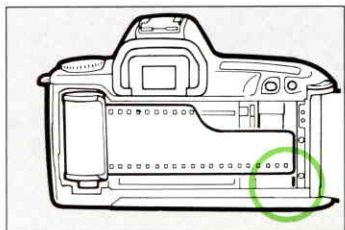

4. Load the film.
Align the film tip with the orange mark and close the back cover until it clicks securely shut.
 - The film will wind forward to the first frame.



5. Focus the camera.

Compose the subject within the AF frame ([]) and lightly press the shutter button to focus.

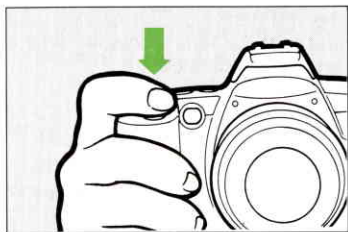

6. Take the photograph.

Press the shutter button down to take the picture.

7. Removing film.

When the last picture on a roll of film has been taken, the film will rewind automatically. When complete, open the back cover and remove the film.

Nomenclature

Self-timer Button
(see page 46)

Film Rewind Button
(see page 49)

LCD Panel (see page 9)

§ Flash Button
(see page 35)

§ Red-eye Reduction Mode
Button (see page 19)

Electronic Input Dial

Shutter Button
(see page 14)

Grip / Battery
Housing
(see page 11)

§ AF Auxiliary Light Emitter
(see page 18)

§ Red-eye Reduction Lamp
(see page 19)

§ Flash (see page 19)

Accessory Shoe (see page 40)
• For attaching Canon Speedlite
flashes and other optional
accessories.

Command Dial
(see page 10)

Strap Fixture
(see page 11)

Back Cover
Latch
(see page 15)

Lens Release Button
(see page 13)

Focus Mode Switch
(see page 13)

Zoom Ring

Manual Focussing Ring
(see page 52)

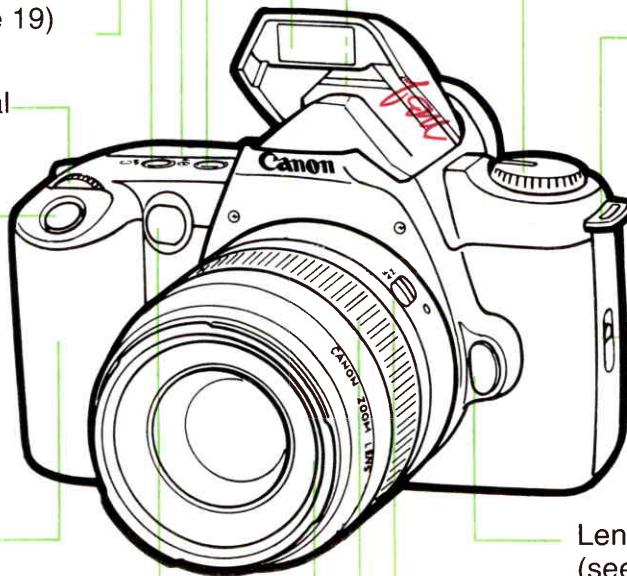

Nomenclature

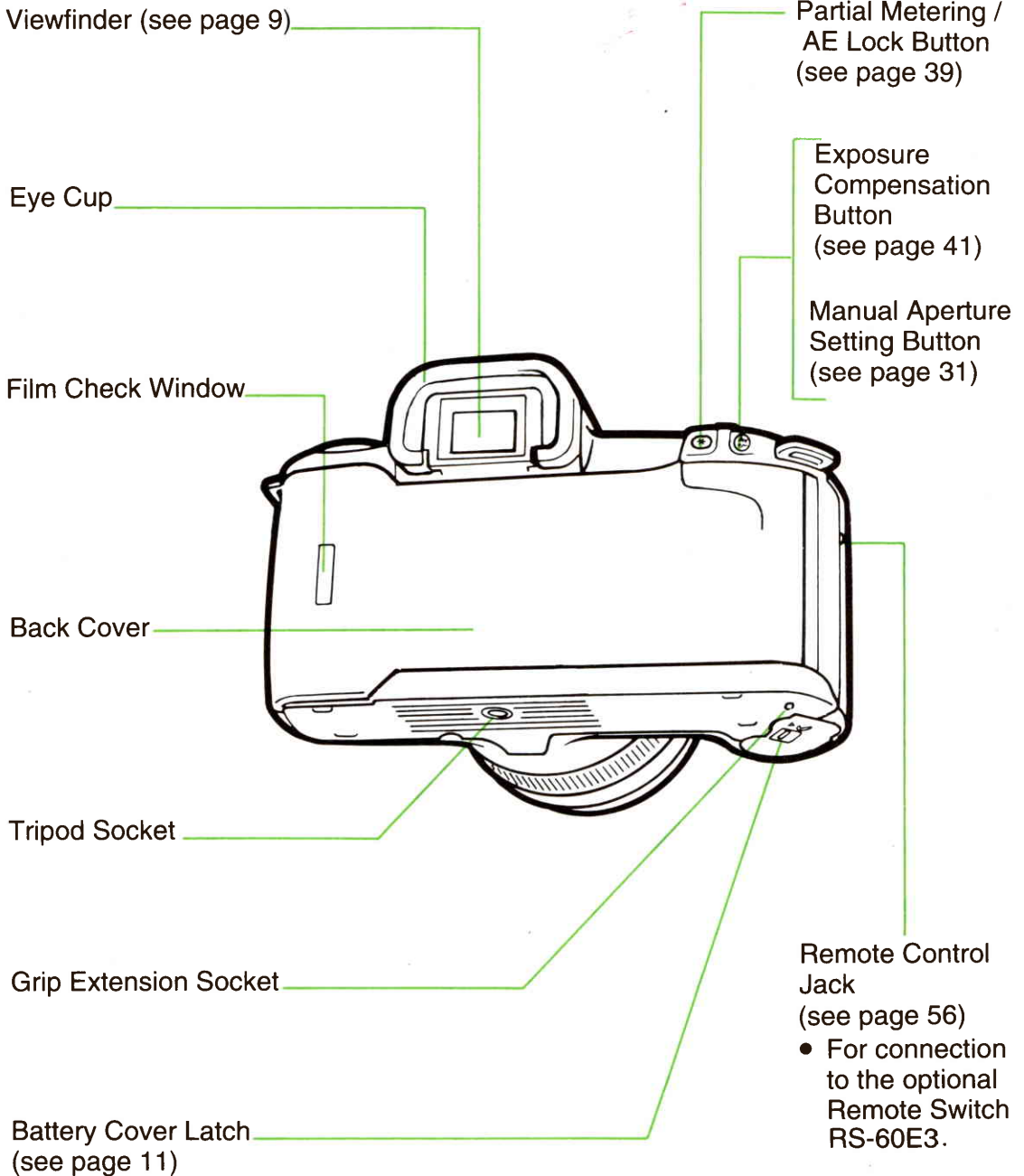

External LCD Panel

The following items are all indicated in the figure below.

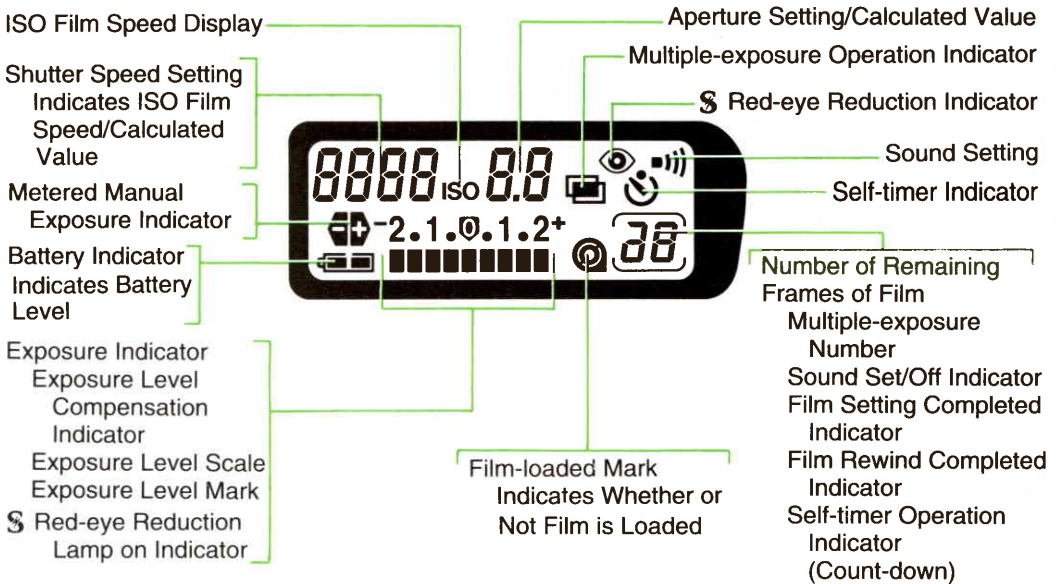

Viewfinder Internal Information Display

The following items are all indicated in the figure below.

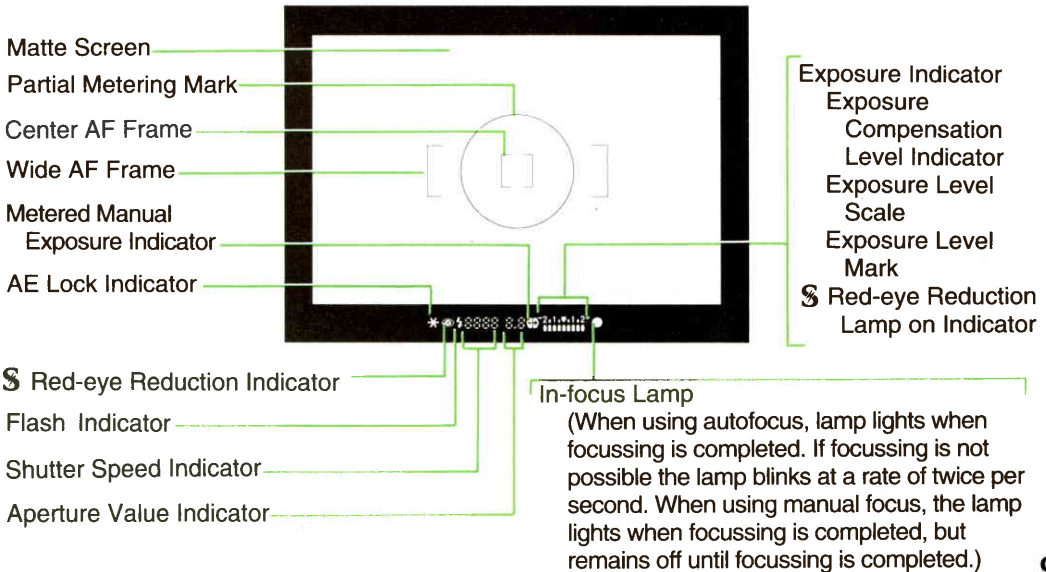

Command Dial

The settings on the command dial are situated around the **⏏** lock (OFF) position.

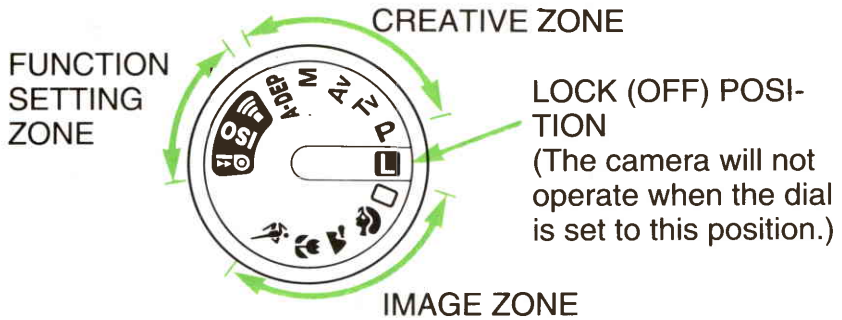

IMAGE ZONE

- 🏃** : Sports (see page 24)
- 🌿** : Close-up (see page 23)
- 🏞️** : Landscape (see page 22)
- 👤** : Portrait (see page 21)
- ⏏** : Full Automatic (see page 17)

CREATIVE ZONE

- P** : Program AE (see page 25)
- Tv** : Shutter-priority AE (see page 27)
- Av** : Aperture-priority AE (see page 29)
- M** : Manual Exposure (see page 31)
- A-DEP** : Automatic Depth-of-field AE (see page 33)

⏏ : Lock/(OFF)

FUNCTION ZONE

- 🔊** : Sound Mode (see page 48)
- ISO** : Manual ISO Speed (see page 47)
- 🔄** : To Rewind Film before End of Roll (see page 49)



When the camera is not in use, please set the command dial to **⏏**. When the camera is placed in a bag, this prevents the possibility of objects hitting the shutter button, continually activating the shutter and draining the battery.

I. PREPARATIONS FOR TAKING PHOTOGRAPHS

An explanation of preparations which must be carried out before taking photographs and of the operation of the shutter button.

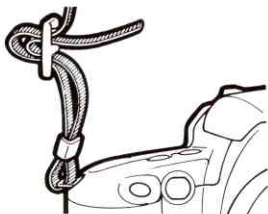

Attaching the Strap

Thread the ends of the neckstrap through the inside of the strap fixture as shown. Before using, tug the strap to ensure that it is firmly secured to the fixture.

Battery Loading and Checking Battery Level

Battery Loading

The camera uses two lithium batteries (CR123A/DL123A).

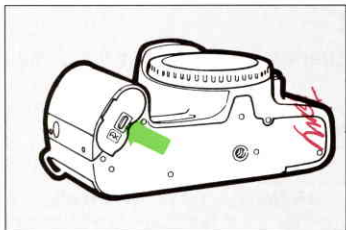

1. Slide the battery cover latch in the direction indicated so that the battery cover opens.

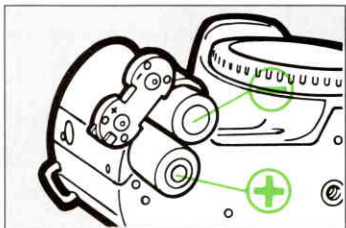

2. Insert the batteries with the + and - terminals pointing in the correct direction as indicated on the battery cover.
3. Close the battery cover.

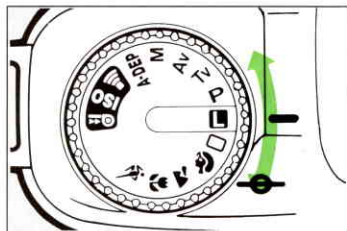

I. PREPARATIONS FOR TAKING PHOTOGRAPHS

Checking the Battery Level



1. Set the command dial to any setting in the image zone or creative zone, releasing the lock.

2. The battery check symbol will be displayed on the LCD panel. The battery check symbol indications have the follows meanings:

-  : The battery power is sufficient.
-  : Battery power is low. Please have new batteries ready.
-  : Replace both batteries with new ones.
- bc* : Please see page 58.

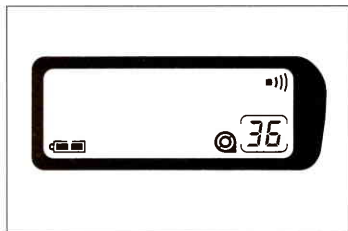

• The command dial lock must be released before a battery check can be carried out.

- Life of two lithium CR123A/DL123A batteries (number of rolls of film that can be taken).

Temperature	Without Flash	With 50% Flash	All Flash
Normal (+20 °C)	60 Rolls	25 Rolls	12 Rolls
Low (-10 °C)	35 Rolls	15 Rolls	7 Rolls

* Tests are based on new batteries, using the EF35-80mm f/4-5.6 II Lens and 24-exp. film. Data based on Canon's Standard Test Method.

* The shooting capacity will be reduced if the autofocus or shutter is used with no film in the camera.



- If there is nothing at all displayed on the LCD panel, check to see if the batteries are inserted upside down. Re-insert the batteries the correct way up.
- Always check the battery level before using the camera.
- Remember that batteries can sometimes be difficult to obtain in certain areas. Be sure to have an adequate supply when traveling overseas or when you expect to take large numbers of photographs.

How to Attach and Remove Lenses

Lens Attachment

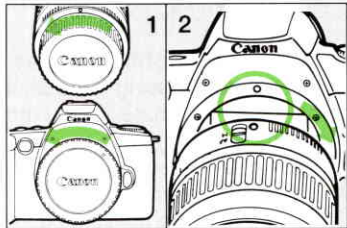

1. Remove the rear lens cap by turning it in the direction of the arrow.

2. Align the red marks on the lens and camera, and turn the lens in the direction of the arrow until it clicks.

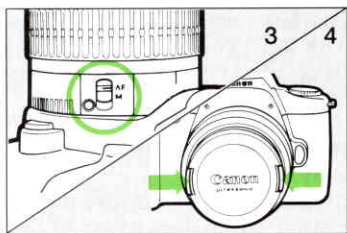

3. Set the focus mode switch on the lens to AF.

- If the switch is set to M, the autofocus can not be used.
- When using the autofocus, do not touch the rotating part of the lens.

4. Remove the front lens cap.

Removing the Lens



To remove the lens, turn the lens in the direction of the arrow on the lens while pressing the lens release button until it stops.

Shutter Button and Autofocus

The EOS shutter button has two stages. The first stage is reached by pressing lightly on the shutter button, and the second stage by pressing the button down completely. The shutter button operates as follows.

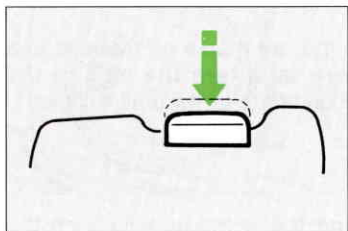

Pressing the shutter button halfway

- This initiates autofocussing (One-shot or Servo) and, once whatever you are shooting (the subject) is in focus, a short intermittent beeping sound is emitted and a green light in the viewfinder (the focus lamp) lights up.
- At the same time, the shutter speed and aperture combination (the exposure) is set. The values are displayed on the LCD panel and in the viewfinder.

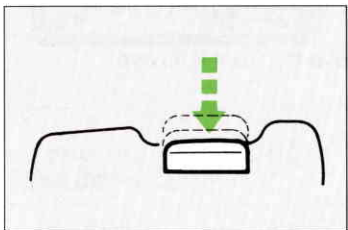

Pressing the shutter button down completely

- The shutter is released, the photograph taken and the film winds on one frame.



If the camera moves at the same moment as the shutter is released, this is called camera shake and can result in blurring of the entire photograph. In order to obtain sharp photographs, please take care of the following two points:

- Avoid moving the camera while taking a photograph.
- Always hold the shutter button at the half-way point before taking photographs.

Loading and Removing Film

How to Load Film

When a film is loaded, it is wound completely to the end. Then as each photograph is taken, the film rewinds frame by frame. The number of photographs remaining out of the total on the roll of film is continually displayed.

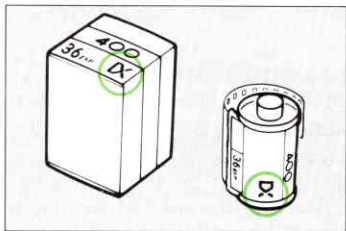

The film has a DX code attached to, allowing the film speed to be set automatically.

- If your film has no DX code on it, the film speed must be set manually. Please read the section “Changing the Film Speed Setting” on page 47.

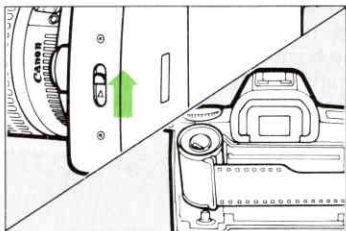

1. Release the command dial lock by setting to any position other than **L**.

2. Open the back cover by raising the back cover latch.

3. Insert the film as shown in the picture, placing one end in first.

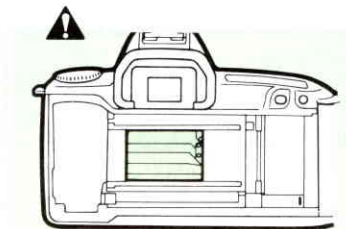

The shutter curtain is an extremely high precision mechanism and must never be touched. When loading film, be careful not to allow your fingers or the tip of the film to come in contact with the shutter curtain, as this can cause damage.

I. PREPARATIONS FOR TAKING PHOTOGRAPHS

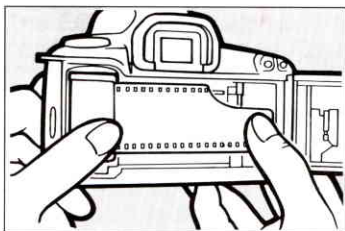

4. Align the tip of the film with the orange mark.

- To ensure that the film lies flat, press lightly on the film cartridge.
- If too much film is protruding, rewind the film cartridge slightly.

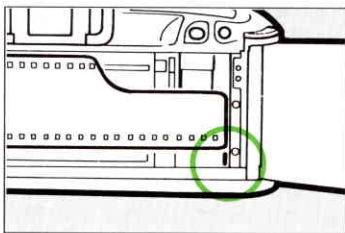

5. Ensure that the film is aligned with the orange mark before closing the back cover.

The film will then begin to wind forward, and the number of available frames will begin to rise. When this has been completed, you will hear a click like that of the shutter release, and the film-loaded mark (Ⓢ) and the number of available frames will appear on the LCD panel.

- If the number of available frames does not appear, this means that the film has not been loaded correctly. Re-load the film correctly.

Removing the Film

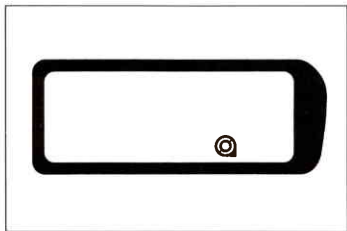

After the last frame on the film has been taken, the film will automatically begin rewinding.

When the film has finished rewinding, the film mark only will appear on the LCD panel. After checking the display, open the back cover and remove the film.

II. TAKING PHOTOGRAPHS

Here we explain a simple way of taking photographs using the image zone on the command dial. Using the settings in the image zone, when the shutter button is pressed the camera takes over, setting everything automatically for your photograph. The various automatic settings possible are shown on page 54 in the section “List of Functions that can be Used Together”. Note that not all combinations are possible.

Taking Photographs on the Full Automatic Mode (□)

Taking photographs on the full automatic mode allows you to take shots of all kinds of subjects with no fuss. As long as the subject is covered by the AF frame, anyone can obtain good results with ease.

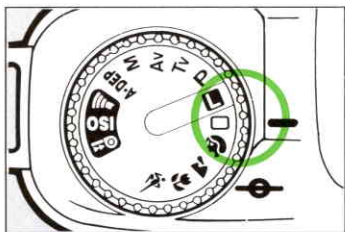

1. Set the command dial to □ .

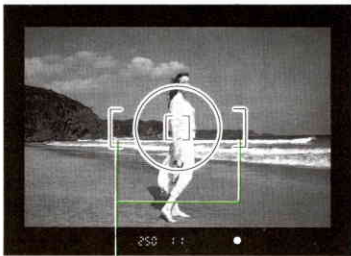

Wide AF Frame

2. Look through the viewfinder and cover the subject with the Wide AF Frame.
- If you wish to focus on a subject outside the Wide AF Frame, see the section “Focussing on Subjects at the Edge of the Viewfinder” on page 20.

II. TAKING PHOTOGRAPHS

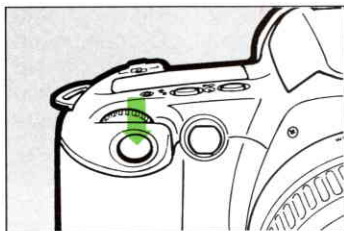

3. Press the shutter button halfway. The subject is brought into focus, and the shutter speed and aperture are set.
 - A green lamp in the viewfinder (the focus lamp) lights up.
 - The shutter speed and aperture value are displayed both on the LCD panel and in the viewfinder.



4. Press the shutter button all the way down to take the picture.



•Blinking shutter speed (camera shake warning)

In the image zone, if there is a danger of a slow shutter speed resulting in camera shake, the shutter speed indicated on the LCD panel and in the viewfinder will blink. If this occurs although you have been holding the camera steadily and taking care how you press the shutter button, we recommend using a tripod. (Even when using a tripod, however, it is still possible for the shutter speed to blink if there is a danger of camera shake.)

•Blinking focus lamp



When the focus lamp blinks, the shutter cannot be released. Please see page 52.

S The AF Auxiliary Light Emitter

When focussing conditions are difficult, the AF auxiliary light emitter comes on automatically to illuminate the subject, making focussing easier.

- The AF auxiliary light emitter can operate in both the image zone and the creative zone.

S Automatic Flash

When the command dial is set to , ,  in the image zone, the flash will automatically pop up and fire if the subject is dark or in back-lit conditions where the background is too bright against the subject.



If you wish to take a photograph without using the flash, such as in places where flash photography is forbidden or for indoor shots where you wish to make use of the available lighting, simply press the shutter button halfway, then push the built-in flash down gently to retract. You can then take your photograph without the flash.



S Red-eye Reduction when Using the Flash

In photographs of people taken using a flash at night or in poorly-lit interiors, the subject's eyes may appear red. This is due to light reflected from the retina, and the phenomena is called "red eye".

When taking a flash shot with the camera set to the red-eye reduction function, the red-eye reduction lamp lights up, gently illuminating the subject's eyes momentarily, reducing the size of the pupils and reducing the chance of the red-eye phenomena occurring.

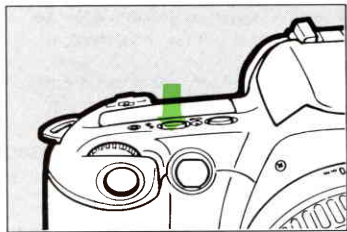
When using the image zone, the red-eye reduction function can be set in the following way.



1. Press the red-eye reduction mode button (the flash button).
 - The LCD panel will display the  mark to indicate that the red-eye reduction has been set.
2. To switch the red-eye reduction function off, press the flash button one more time.
 - The  mark on the LCD panel will go out, indicating that the red-eye reduction function has been switched off.

II. TAKING PHOTOGRAPHS



- When the red-eye reduction lamp is on, the shutter will be released about 1 second after the shutter button is completely pressed down.
- When the red-eye reduction lamp is on, the display in the viewfinder will indicate this with the  mark.



The red-eye reduction lamp is effective when the subject is looking towards it, however the level of effectiveness can vary from person to person.

Focussing on Subjects at the Edge of the Viewfinder

When taking photographs where the subject is outside the center focus mark in the viewfinder, focus in the following way:



1. Cover the subject you wish to have in focus with the AF frame and press the shutter button halfway.



2. Keeping the shutter button pressed halfway, recompose the picture.
3. Press the shutter button all the way down to take the picture.

Taking Photographs in Portrait Mode ()



Use this setting when you wish to take a photograph with the subject in the foreground clearly emphasized against a blurred background.

- By pressing the shutter button down and holding it, continuous shooting is possible.
- S** If the subject appears dark against a bright background, the flash will fire automatically.

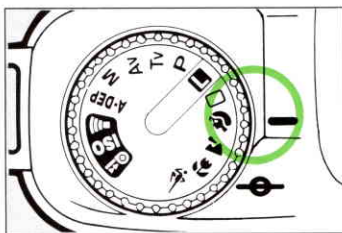

Set the command dial to .



- If the subject's head and shoulders fill up most of the center of the viewfinder, an effective background blur can be achieved. In addition, a better effect can be achieved with the subject as far away from the background as possible.
 - A more effective background blur can be achieved when using a telephoto lens. If using a zoom lens, set the lens to the telephoto setting (80mm in the case of a 35-80mm lens).
- S** If  blinks in the viewfinder, attach an external flash unit and use flash when taking the picture.

Taking Photographs in Landscape Mode ()



For expansive landscapes, sunset shots and night-time photographs, please use the landscape setting.

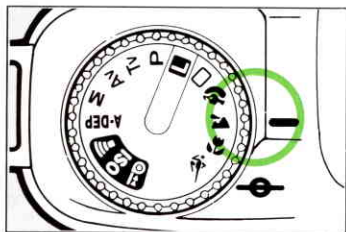

This setting is indicated as  on the command dial.



When using your zoom lens, use the wide-angle setting (35 mm in the case of a 35-80mm lens). This will create a feeling of expansiveness and add depth to your photographs.



- ⚠ If the built-in flash pops up when you set the command dial to , press the flash gently down until it retracts before shooting. You will not be able to take the picture as you see it if the flash is left on.
- If the shutter speed indicator blinks, there is a danger of camera shake, so be sure to hold the camera steady and take care how you press the shutter button. Otherwise we recommend using a tripod. (Even when using a tripod, however, it is still possible for the shutter speed to blink if there is a danger of camera shake.)

Taking Photographs in Close-up Mode (🌱)



Use the macro function built in to your lens for close-up photography when you want to take photographs of plants and insects in maximum magnification. **S** If the subject is dark or back-lit by, the built-in flash will fire automatically.

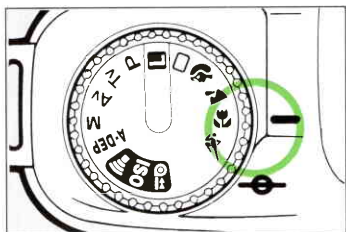

Set the command dial to 🌱.



- Take your photograph from as close to the subject as your lens permits.
- When using a zoom lens, you can achieve a higher level of magnification in your photograph by setting the lens to telephoto.
- For full-scale macro photography, we recommend our optional macro lenses and ML-3 macro ring light.

S If 🌱 blinks in the viewfinder, attach an external flash unit and use flash when taking the picture.

Taking Photographs in Sports Mode ()

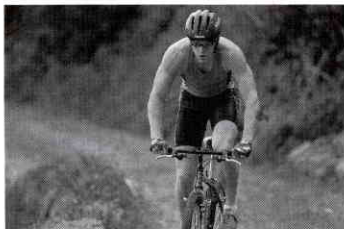

Please use this setting when you wish to freeze fast-moving subjects, such as sports activities and events.

- If you keep the shutter button pressed down, continuous photographs can be taken.

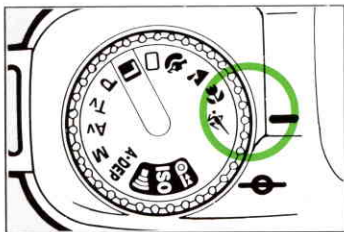

Set the command dial to .



- We recommend that you use film with a speed of ISO 400 or over.
- We also recommend telephoto lenses for sports photography, such as the EF80-200mm f/4.5 - 5.6 USM, EF75 - 300mm f/4 - 5.6 USM, etc.



S If the built-in flash pops up when you set the command dial to , press the flash gently down until it retracts before shooting. You will not be able to take the picture as you see it if the flash is left on.

- If the shutter speed indicator blinks, there is a danger of camera shake, so be sure to hold the camera steady and take care how you press the shutter button. Otherwise we recommend using a tripod. (Even when using a tripod, however, it is still possible for the shutter speed to blink if there is a danger of camera shake.)

III. TAKING DIFFERENT KINDS OF SHOTS

Here we will explain how to use the wide range of functions built into the camera when the command dial is set to the creative zone. The functions available on the creative zone setting allow you to precisely determine the results you want to achieve.

Taking Photographs on the Program AE Settings (P)



Setting the camera to this setting is just as easy as setting to the (□) full auto mark. The camera sets both shutter speed and aperture automatically to match the brightness of the subject. This function is called Program AE.

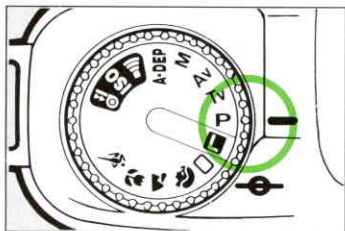

1. Set the command dial to **P** .



When using the creative zone, the LCD panel and the viewfinder will display the shutter speed, the exposure level scale as well as the exposure level mark. The exposure level mark indicates the exposure level when using the exposure compensation or when selecting the exposure manually.

III. TAKING DIFFERENT KINDS OF SHOTS

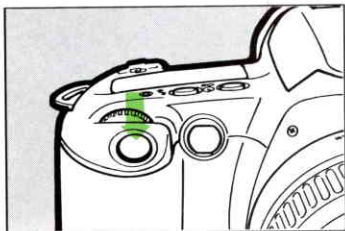

2. Press the shutter button halfway to focus on the subject.
 - The shutter speed and aperture will be indicated on the LCD panel and in the viewfinder.



3. Check the shutter speed and the aperture and take the photograph.

Program Shift

In Program AE mode, the automatically set shutter speed and aperture combination can be changed while maintaining the same exposure. This function is called Program Shift.

To shift the program, press the shutter button halfway and turn the electronic input dial to select the desired shutter speed or aperture value.

- After taking a photograph the Program Shift switches off automatically and returns to the original program.
- Program Shift is not possible when using a flash.

Six-second Timer

Even if you release the shutter button after pressing it down halfway, the exposure data (shutter speed and aperture) in the viewfinder and LCD panel appear for about six seconds.

Shutter-priority AE Settings (Tv)

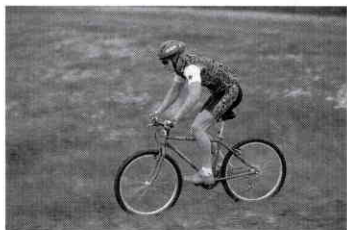

Fast shutter speed

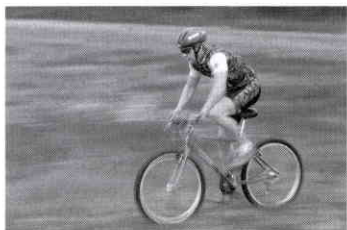

Slow shutter speed

At the shutter-priority setting, the camera automatically sets the aperture value for the lighting conditions. This is called Shutter-priority AE.

Faster shutter speeds allow you to take photographs that freeze moving subjects, while with slower shutter speeds you can capture objects with a feeling of motion.



If you set the shutter speed at 1/15 sec you can take clear pictures of your television set screen.

- When taking a photograph of a TV screen, be sure to hold the camera very steady, or use a tripod.

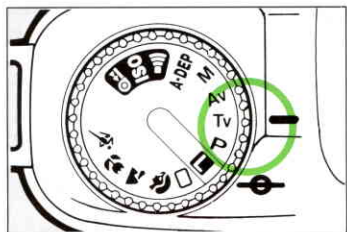

1. Set the command dial to Tv .

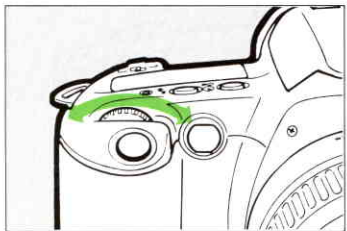

2. Turn the electronic input dial to the desired shutter speed setting.

III. TAKING DIFFERENT KINDS OF SHOTS

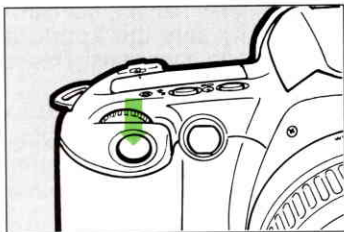

3. Press the shutter button halfway to focus on the subject.
 - The shutter speed and aperture will be indicated on the LCD panel and in the viewfinder.



4. Check the shutter speed and the aperture and take the photograph.



- If the smallest aperture value (i.e. maximum aperture) of the lens blinks in the viewfinder, reduce the shutter speed by turning the electronic input dial until the blinking stops.



- If the largest aperture value (i.e. minimum aperture) of the lens blinks in the viewfinder, increase the shutter speed by turning the electronic input dial until the blinking stops.



Aperture-priority AE Settings (Av)



Smaller aperture value



Larger aperture value

When you set the aperture, the camera automatically selects the correct shutter speed to suit the lighting conditions around the subject. This is called Aperture-priority AE.

A smaller aperture value (i.e. larger aperture) is suitable for taking beautiful portrait photographs, with effectively graduated or blurred backgrounds. However, with a small aperture value, landscapes will blur.

A larger aperture value (i.e. smaller aperture) gives a greater depth-of-field suitable for clear photographs of expansive landscapes, where everything from nearby objects to background details are sharply in focus.

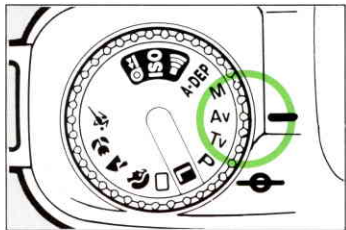

1. Set the command dial to Av .

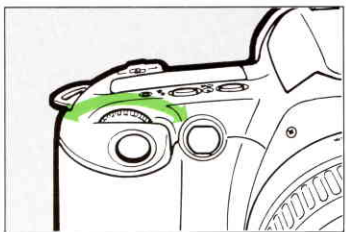

2. Turn the electronic input dial to the desired aperture value.

III. TAKING DIFFERENT KINDS OF SHOTS

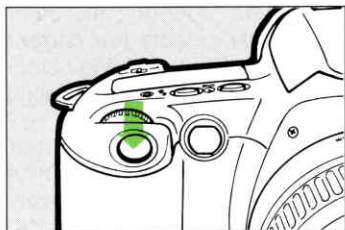

3. Press the shutter button halfway to focus on the subject.
 - The shutter speed and aperture will be indicated on the LCD panel and in the viewfinder.



4. Check the shutter speed and the aperture and take the photograph.



- If the shutter speed blinks at 30", turn the electronic input dial to reduce the aperture value until the blinking stops.



- If the shutter speed blinks at 2000, turn the electronic input dial to increase the aperture value until the blinking stops.



Manual Exposure Settings (M)

Rather than leaving everything to the camera, this mode allows you take artistic photographs by selecting the shutter speed and aperture value yourself. You can check that the combination of shutter speed and aperture value is suitable by checking the exposure level mark on the exposure level scale.

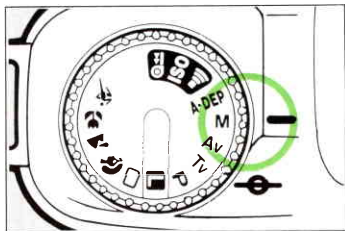

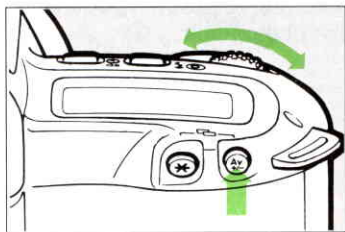

1. Set the command dial to **M**.



2. Turn the electronic input dial to set the desired shutter speed.
3. While pressing the manual aperture setting button, turn the electronic input dial to set the desired aperture value.

4. Press the shutter button halfway to focus on the subject.
 - The shutter speed and aperture will be indicated on the LCD panel and in the viewfinder.



Correct exposure	
Overexposure	
Underexposure	

5. Adjust the exposure according to the exposure level mark.

Correct exposure: This is the metered standard which will set the exposure.

Overexposure: Select a faster shutter speed or adjust the aperture until correct exposure is obtained.

Underexposure: Select a slower shutter speed or adjust the aperture until correct exposure is obtained.

6. When correct exposure is obtained, take the photograph.

Depth-of-field AE Settings (A-DEP)

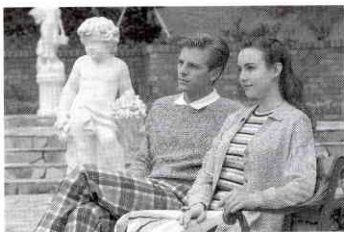

This setting allows you to take photographs automatically with everything from the foreground to background in sharp focus, such as a souvenir photograph where you want both the group in the foreground and the background to be in focus.

Everything will be placed in focus from the subject within the AF frame to objects in the far distance.

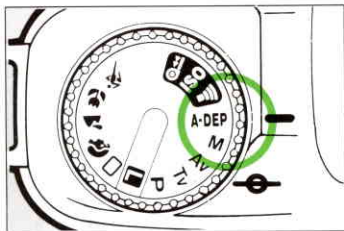

1. Set the command dial to **A-DEP**.

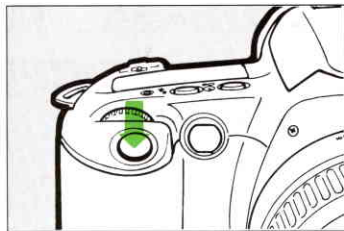

2. Press the shutter button halfway to focus on the subject.

- The shutter speed and aperture will be indicated on the LCD panel and in the viewfinder.



3. Check the shutter speed and the aperture and take the photograph.

III. TAKING DIFFERENT KINDS OF SHOTS



- If the aperture value flashes, the exposure level is correct but the desired depth of focus can not be obtained. Use a wide-angle lens or move back from the subject.
- Not all changes in combination of shutter speed and aperture value are possible. This setting is designed to select a slower shutter speed, so it is important to hold the camera steady when taking the photograph or use a tripod.
- Using the flash with the command dial set to **P** will achieve the same results.
- If the focus mode switch of the lens is set to **M**, photographs can not be taken on the **A-DEP** setting.

Flash Photography with the Built-in Flash (Rebel X S only) ()



The built-in flash can be used at any time in the creative zone.

Use the flash when the subject is heavily shaded or when you wish to highlight people's faces. Using the built-in flash you can obtain photographs where both the subject and the background have a natural feel.

When the flash is used, the shutter speed will be at or below 1/90 sec.

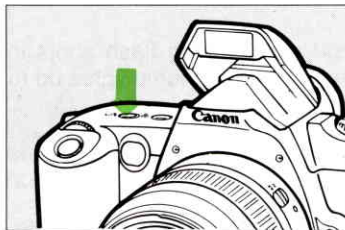

1. Press the flash button to raise the flash.

- Push the flash gently down to retract.

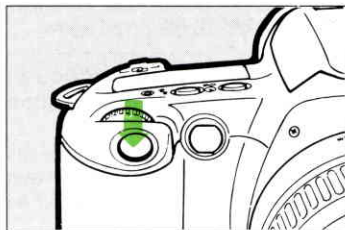

2. Press the shutter button halfway to focus on the subject.

3. Check that the  symbol in the viewfinder is on before taking the photograph.



III. TAKING DIFFERENT KINDS OF SHOTS





- If the built-in flash is used when a lens hood is attached, the hood can cause shading of the flash light. The lens hood must be removed before using the built-in flash.
- An external flash cannot be used together with the built-in flash.
- Light from the built-in flash may be blocked when using the following lenses. When using such a lens we recommend using a dedicated external flash unit.
 - Large aperture lenses such as the EF 20~35mm f/2.8L and EF28~70mm f/2.8L.
 - Super-telephoto lenses such as the EF 300mm f/2.8L and EF 600mm f/4L.
- The built-in flash cannot be used when a special flash or the accessory shoe cover is attached to the accessory shoe.
- When using an external flash, push the built-in flash down to retract.

Setting the Red-eye Reduction Function

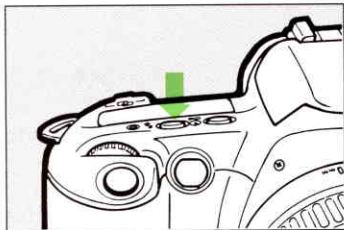
When the red-eye reduction function is set when taking flash shots in conditions where red-eye is likely, the red-eye reduction lamp lights up to reduce the chances of the phenomena from occurring.



1. When the flash is raised, press the flash button (the red-eye reduction mode button) one more time.
 - The LCD panel will display the  mark to indicate that the red-eye reduction has been set.
2. To switch the red-eye reduction function off, press the flash button one more time.
 - The  mark on the LCD panel will go out, indicating that the red-eye reduction function has been switched off.



If the red-eye reduction function is cancelled in the creative zone, the red-eye reduction function set in the image zone will also be cancelled.

Taking Night-time Shots of People



When taking shots of sunsets or night-time shots of people against a background, set the command dial to **Av** (Aperture-priority AE). When taking flash pictures with the aperture value on a lower setting, the flash illuminates the subjects, while the background is also captured clearly because of the slow shutter speed. This is called Slow Syncro Photography.

- S With the Rebel X, the same type of flash photography is possible with an external flash.



When taking a slow syncro shot, please use a tripod to avoid camera shake.

Built-in Flash Shooting Distance Range (when using the EF 35-80 mm f/4-5.6 II)

ISO	35 mm		80 mm	
	Negative Film	Slide Film	Negative Film	Slide Film
100	0.5 - 4.2 m 1.6 - 13.8 ft.	0.7 - 3 m 2.3 - 9.8 ft.	0.5 - 3 m 1.6 - 9.8 ft.	0.5 - 2.1 m 1.6 - 6.9 ft.
400	1 - 8.4 m 3.3 - 27.5 ft.	1.5 - 6 m 4.9 - 19.7 ft.	0.7 - 6 m 2.3 - 19.7 ft.	1 - 4.2 m 3.3 - 13.8 ft.

Checking exposure display information when using flash

Shooting Mode	Warning Display	Condition	Note
Tv (Shutter-priority AE)	The maximum aperture value for the lens being used blinks.	The background is overexposed.	The subject is correctly exposed.
	The minimum aperture value for the lens being used blinks.	The background is underexposed.	
Av (Aperture-priority AE)	The 1/90 sec shutter speed blinks.	The background is overexposed.	The subject is correctly exposed. If the aperture value is changed, the shutter speed may light up.
	The 30" shutter speed blinks.	The background is underexposed.	

Checking the shutter speed and aperture value when using the flash

Shooting mode	Shutter speed	Aperture value
P (Program AE)	Automatically set to 1/90 sec.	Flash aperture value automatically set according to existing lighting and TTL program.
Tv (Shutter-priority AE)	Manually set to any desired shutter speed of 1/90 sec. or slower (*).	Aperture value automatically set according to the set shutter speed and existing lighting.
Av (Aperture-priority AE)	Automatically set between 30" and 1/90 sec. according to the set aperture value and existing lighting.	Manually set to any desired aperture value.
M (Manual)	Manually set to any desired shutter speed of 1/90 sec. or slower (*).	

(*) If the shutter speed is set to a value faster than 1/90 sec., the camera will automatically lower it to 1/90 sec.

Partial Metering (AE Lock • Center-weighted Metering)

In a scene with high contrast between the subject and background, switch to partial metering to limit the metering area to the center of the frame. This allows accurate metering of the subject without influence from the background. Partial metering operation locks in the exposure (AE lock) and focuses the subject using the center focusing point.

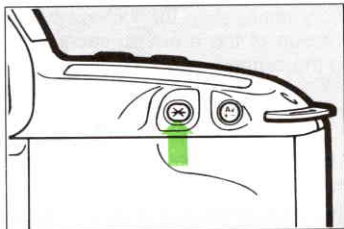

Partial metering mark ②



Press the partial metering button and/or the shutter button within six seconds after the exposure is displayed in the viewfinder. If more than 6 seconds elapse, start the procedure again from step 1.

- 1) Set the command dial to a creative zone mode. Compose the scene, press the shutter button halfway, then let up on the shutter button.
 - If you do not remove your finger from the shutter button once, the * button will not function even if pressed.
- 2) Cover the main subject with the viewfinder's central partial metering mark, then press the * button.
 - “*” appears in the viewfinder display and the exposure is locked by the AE lock function (→①).
 - Keep the * button pressed until you take the picture.
- 3) While holding the * button pressed, press the shutter button halfway to focus the subject.
 - “●” appears in the viewfinder display and the subject is focused with the central focusing point (→②).
- 4) Recompose the scene as desired and take the picture.

Flash Photography with the Speedlite 200E (may be optionally available in some areas)

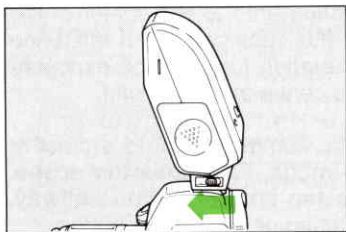

When the “⚡” indicator blinks in the viewfinder, attach the Speedlite 200E to the accessory shoe before taking pictures.

- After attaching the Speedlite 200E to the accessory shoe, slide the lock switch in the direction of the arrow to secure the flash to the camera.
- The “⚡” indicator does not blink in creative zone modes.

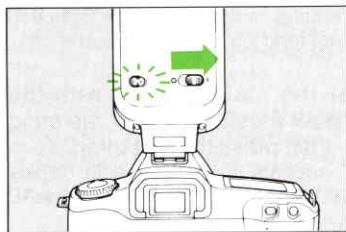

1. Set the Speedlite 200E's main switch to “I”. The ready lamp lights up when flash charging is completed.

- The viewfinder's “⚡” indicator also lights up when flash charging is completed.

2. Compose the picture and press the shutter button to take the picture.

- For flash pictures, do not press the shutter button completely until the flash unit's ready lamp lights up.

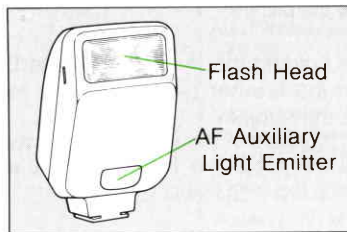

* For details, refer to the instructions provided with the Speedlite 200E.

Exposure Compensation

Deliberately changing the exposure when taking a photograph is called exposure compensation. The compensation range is up to ± 2 steps in half-step increments.

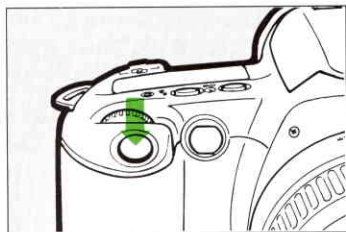

1. Set the command dial to the creative zone.
2. Press the shutter button halfway to focus on the subject.
 - The shutter speed and aperture will be indicated on the LCD panel and in the viewfinder.

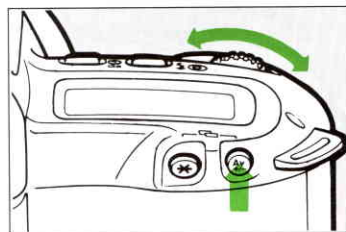

3. While pressing the exposure compensation button, turn the electronic input dial until the exposure level mark is set to the desired exposure compensation amount.



- “+” will increase the exposure level, “-” will reduce it.
- To cancel exposure compensation, set the exposure level mark on the exposure level mark scale to 0.



If the command dial is set to the image zone, the exposure compensation will be canceled.

4. Take the photograph.

III. TAKING DIFFERENT KINDS OF SHOTS



When using a shutter speed of 1/125 sec., and an aperture value of 5.6, compensating the exposure level scale by one increment will change the value of the exposure reading on the display as follows.

	-1	←	0	→	+1
Shutter Speed	250	←	125	→	60
Aperture Value	8.0	←	5.6	→	4.0

Multiple-exposure Photography

With multiple-exposure photography you can release the shutter to expose the same frame of film two or more times to obtain special effects.

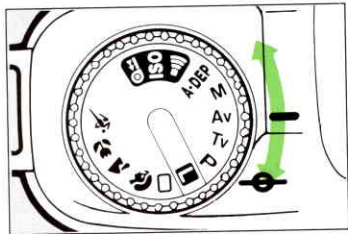

1. Set the command dial to the creative zone.

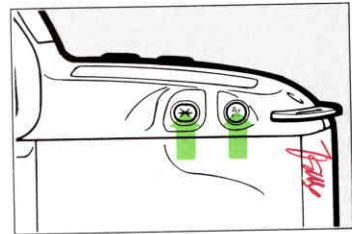

2. Press the partial metering and the exposure compensation buttons at the same time. The  symbol will appear on the display.

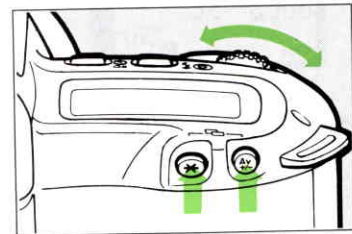

3. While holding down both the partial metering and the exposure compensation buttons, set the number of multiple-exposures required using the electronic input dial.
 - The number of multiple-exposures will appear on the film counter of the LCD panel.
 - The number of multiple-exposures can be set up to 9.
 - To cancel the multiple-exposure function, reset the number of multiple-exposures to 1.

4. Compose the photograph and take the picture.

- If you press the shutter button halfway after taking the first frame, the  symbol will blink on the display panel to confirm that multiple-exposure photography is in progress.
- When the pre-set number of multiple-exposures have been taken, the film will automatically wind on to the next frame and the multiple-exposure function will be cancelled.
- To cancel the multiple-exposure function in the middle of shooting, reset the number of remaining frames on the display as above.



When superimposing multiple exposures on a single frame, it is necessary to compensate for the exposure value from the very beginning. Read the section on "Exposure Compensation" on page 41.

The following table will also serve as a guideline for determining the required compensating level.

Number of multiple-exposures	2	3	4
Compensation level	-1.0	-1.5	-2.0

- The compensation values given here are intended as a rough guideline. As the required compensation values can change according to actual conditions, obtain the required photographic data beforehand.

Taking Pictures Using the Self-timer

The self-timer can be used in the image zone and the creative zone. Please use a tripod when taking self-timer shots.

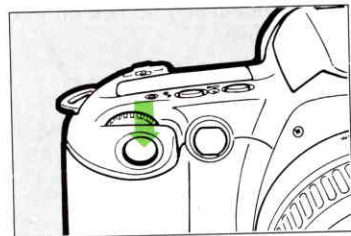
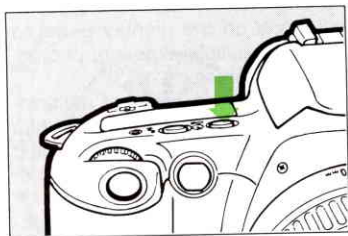

- Standing in front of the camera when pressing the shutter button can result in out-of-focus pictures.
- To cancel the self-timer halfway, press the self-timer button again.

- When using the self-timer, the count-down is displayed on the LCD panel in seconds to the moment the shutter is released.
- S** When using the self-timer with a flash shot, if the red-eye reduction function is set, the red-eye reduction lamp will come on two seconds before the shutter is released.

1. Press the self-timer button.
 - The  mark will appear in the LCD panel.
 - If the self-timer button is pressed again, the self-timer will be cancelled.

2. Press the shutter button down halfway to set the focus and check the shutter speed and aperture value.



3. Compose the picture and press the shutter button down fully while looking through the viewfinder. A beeper tone sounds to monitor the 10-second countdown.
For the first eight seconds, the beeper sounds slowly at a rate of twice per second. When only two seconds are left, the rate increases to eight times per second.

Changing the Film Speed Setting

When using non-DX coded film, or when you wish to set the film speed (ISO number) yourself, the film speed can be selected manually in the following way. The range of possible settings is from ISO 6-6400.

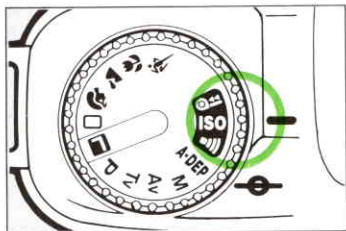

1. Set the command dial to **ISO**.
 - The letter **ISO** and the film speed number will appear on the display panel.

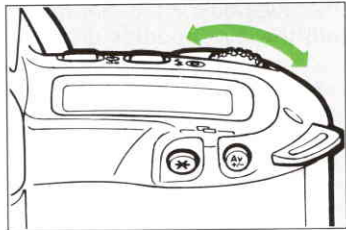

2. Turn the electronic input dial to set the desired film speed.
3. Reset the command dial back to the desired photographic mode.



The film speed setting will remain at the previous set value until a DX coded film is loaded into the camera or until the film speed is reset.

Shutting off the Beeper after Focussing

In certain circumstances, the electronic beeper could be undesirable, depending on where you are taking photographs. Therefore, when taking pictures in the creative zone, the beeper can be switched off.

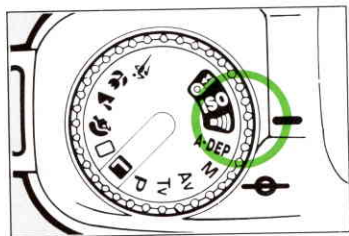

1. Set the command dial to .

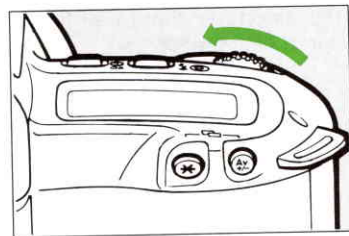

2. Turn the electronic input dial to the left until the film counter displays "0".

- The  symbol on the display panel will go off. When focussing, the beeper will not sound.
- To reset the beeper to the original setting, repeat the above steps and set the film counter to "1".



3. Reset the command dial back to the desired photographic mode.

Removing Film before the End of the Roll

If you want to remove the film from the camera before the end of the roll, rewind the film and remove it in the following way.

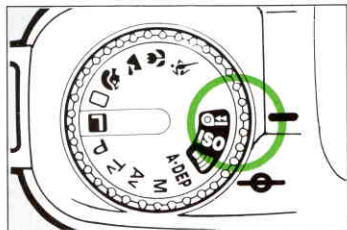

1. Set the command dial to **M**.

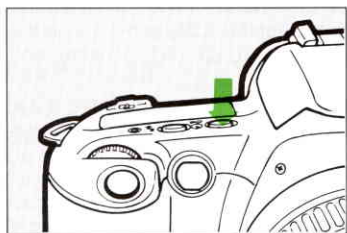

2. Press the film rewind button (the self-timer button) and keep it held down for at least one second.
 - The film will begin to rewind, and as soon as winding is completed, you will hear a sound like that of the shutter release. The film-load mark only will appear on the display panel.

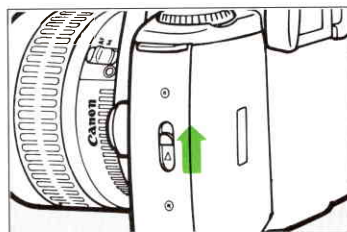

3. Open the back cover and remove the film.



If you remove a film before the end of the roll without using the film rewind function, the next film loaded will continue to wind back into the film cartridge. To prevent this, close the back cover once and press the shutter button down fully before loading the new film.

IV. OTHER INFORMATION

The following section contains data designed to help you get the best from your camera. It contains an explanation of the basic terms used in photography, some tips on how to use the camera's various functions when taking pictures, and an introduction to some of the accessories available.

Basic Photographic Terms

Shutter Speed

The shutter integrated in the camera body regulates the length of time that the film is exposed to light. The length of time that the shutter remains open is called the shutter speed. The camera displays the shutter speed on the LCD panel and in the viewfinder, in a range from 2000 (1/2000th of a second) to 30" (30 seconds), and bulb.

Aperture Value

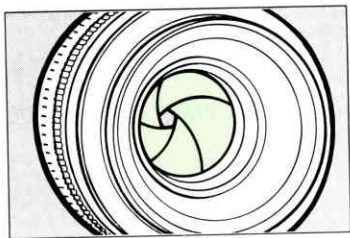

Integrated into the lens, the aperture is an opening which can be widened and narrowed to regulate the amount of light allowed to enter the camera. The size of the opening is called the aperture value. The camera displays the aperture value on the LCD panel and in the viewfinder in a range from 1.0 to 32, although this may vary depending on the lens used.

Film Speed (ISO Number)

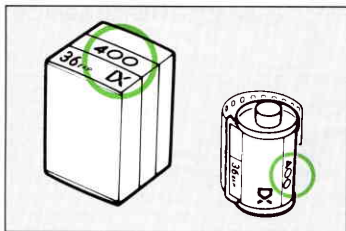

The film speed is a value which indicates the level of the film's sensitivity to light, as set by the ISO (International Standardization Organization). The camera displays the film speed on the display panel in a range from 6-6400.

The higher the ISO number, the higher the film's sensitivity to light. While film with a higher sensitivity is more suitable for low-light situations. The higher the film speed film, the lower the level of light required for photography, and so pictures can even be taken in dark places.

Depth-of-field

Depth-of-field is the area that is in focus in front of and behind the subject which is also in focus. When the aperture is smaller (i.e. when the aperture value is larger), the area in focus is more extensive, and this is called a deep depth-of-field.

Conversely, when the aperture is larger (i.e. when the aperture value is smaller), the depth-of-field becomes shallower.

Depth-of-field has the following properties.

- (1) The larger the aperture value, the deeper the depth-of-field.
...increase the aperture value to create a feeling of depth.
- (2) With the same aperture value, a greater depth-of-field will be obtained using a lens with a shorter focal length.
...using a wide-angle lens or the wide angle setting on your zoom lens will create a feeling of expansiveness and depth.
- (3) With the same aperture value, a greater depth-of-field can be achieved the further away the main subject in focus is.
- (4) If the subject in focus is in the center field, the depth-of-field will be shallower.

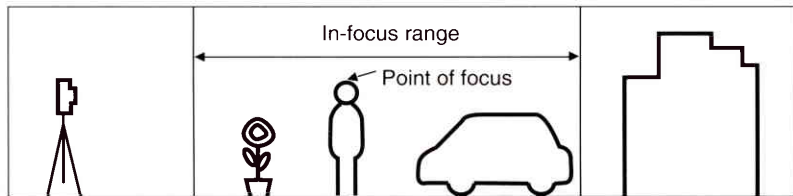









Troubleshooting Tips

Before you start thinking that there might be something wrong with your camera, please check the points on the following checklist. If this doesn't solve the problem, please take the camera to your nearest Canon service facility (these are listed at the back).

Problem	Cause	Solution	See page
1. No display on panel	Are the batteries exhausted?	Replace the batteries.	11
	Are the batteries the wrong way round?	Reload the batteries correctly.	11
2. The shutter doesn't release.	Is the film loaded correctly? (Is the film counter on the display blank?)	Reload the film correctly.	15
	Check that there is no rewind film in the camera. (Have you checked that the film counter on the display is blank?)	Replace the film.	15
	Is the camera focussed? (Is the focus lamp in the viewfinder blinking?)	Press the shutter button halfway again. If it still does not focus, set the focus mode switch to M (manual) and focus manually.	61
3. Photographs come out blurred.	Is the focus mode switch on M (manual)?	Reset the focus mode switch to AF (Autofocus).	13
	Did you move your hands when shooting?	Press the shutter button steadily, without shaking the camera.	14
4. The bc indicator on the display panel is lit.	The batteries are very low.	Replace the batteries. You can continue taking photographs when the bc indicator goes off and the battery lamp comes on.	12
	There may be some other reason to consider as to why the camera is not operating correctly.	If, when the shutter button is pressed halfway, the bc indicator goes off and the battery mark comes on, photographs can be taken normally. <ul style="list-style-type: none"> • If after doing the above the bc indicator does not go out, there may be a problem with the camera. Please take it to your nearest Canon service facility. 	12 See back page

What to Do If the Exposure Meter on the LCD Panel Blinks

Command dial mark	Warning display (Flashing)	Meaning	Notes
P	 <p>Shutter speed 30" and minimum aperture value of the lens in use.</p>	Subject is too dark.	Use flash.
	 <p>Shutter speed 2000 and maximum aperture value of the lens in use.</p>	Subject is too bright.	Use an ND filter.
Tv	 <p>Minimum aperture value of the lens in use.</p>	Subject will be underexposed.	Turn the electronic input dial to a slower shutter speed.
	 <p>Maximum aperture value of the lens in use.</p>	Subject will be overexposed.	Turn the electronic input dial to a faster shutter speed.
Av	 <p>Shutter speed 30"</p>	Subject will be underexposed.	Turn the electronic input dial to a smaller aperture value.
	 <p>Shutter speed 2000</p>	Subject will be overexposed.	Turn the electronic input dial to a larger aperture value.
A-DEP	 <p>Calculated aperture value.</p>	Desired depth-of-field cannot be obtained.	<ol style="list-style-type: none"> 1) Move farther away from the subject and try again. 2) When using a zoom lens, set to the wide-angle position.
	 <p>Shutter speed 30" and minimum aperture value of the lens in use.</p>	Subject is too dark.	Use flash.
	 <p>Shutter speed 2000 and maximum aperture value of the lens in use.</p>	Subject is too bright.	Use an ND filter.

List of Functions that can be Used Together

Command dial	Autofocus		Film winding		Metering method			Built-in flash	
	One-shot	AI Focus	Single frame	Continuous	Evaluative metering	Center-weighted average metering	Partial metering	Automatic	Manual
		●	●		●			●	
	●			●	●			●	
	●		●		●			—	—
	●		●		●			●	
		●		●	●			—	—
P		●		●	●		(●)*		●
Tv		●		●	●		(●)*		●
Av		●		●	●		(●)*		●
M		●		●		●	(●)*		●
A-DEP	●		●		●				●

(*) Partial metering is only possible when the partial metering button is pressed.

One-shot: The exposure is set at the same time as the camera focusses on the subject. The shutter can not be released until focussing is complete.

AI Focus: When a subject taken using the One-shot autofocus continues to move, the movement of the subject is determined and the AI Servo autofocus automatically adjusts.

AI Servo: This allow you to focus continuously on a moving subject. The exposure will be set immediately before the shutter is released.

Continuous shooting: When the shutter is held down, one frame per second will be taken continuously.

Evaluative metering: This sets a suitable exposure for shots where there is a large difference between the light level of the subject and that of the background.

Partial metering: This ensures correct exposure of the area within the partial metering range mark in the viewfinder.

Center-weighted average metering: This provides metering based on values of the center of the viewfinder averaged out for the entire photograph.

AF Mode and Film Winding

Film winding	One-shot	AI Servo
Single frame	The picture can not be taken until the focussing is complete. Setting are made at the same time as the focus. Exposure is determined by evaluative metering. (The exposure value is calculated in advance).	This allows the camera to continuously focus on a moving object. The exposure is set when the shutter is released.
Continuous photography	Continuous shots are taken under the same conditions as above. (About 1 frame per second).	The same conditions as above apply to continuous shots. Focussing is carried out during continuous photography (at the rate of about one frame per second).



Canon Speedlite Flashes (Sold Separately)

Speedlite flashes include the powerful 430EZ zoom flash, which clips on to the accessory shoe and has a maximum guide number of 43/141 (m/ft) at ISO 100, the 300EZ, which has a maximum guide number of 30/98 (m/ft) at ISO 100, and the 200E, which has a maximum guide number of 20/66 (m/ft) at ISO 100.



It is recommended that you use Canon Speedlite flashes with your EOS camera. Particular care must be taken with flash units designed for use with cameras of other manufacturers (such as those with a hot shoe connection) and with high-current flashes and auxiliary flash units, etc. which could cause damage to your camera.

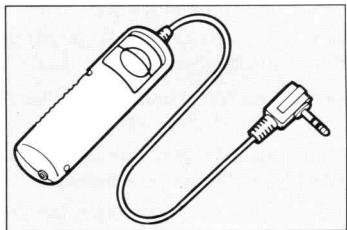

Remote Switch RS-60E3

The remote switch RS-60E3 is attached to the camera's remote control jack and is intended for use when taking macro or long exposure shots (such as bulb shots) using a tripod. The special cable release avoids shaking the camera.

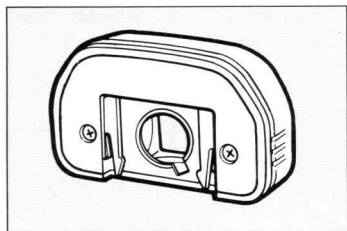

Eye-piece Extender EP-EX15

The eye-piece extender EP-EX15 extends the EOS viewfinder by 15 mm. Attaching the extender increases the magnification of the viewfinder by about 0.5.

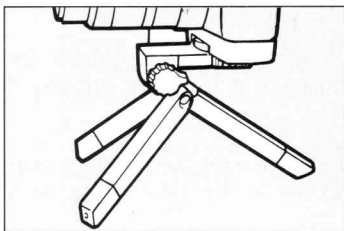

Grip GR-80TP

The grip GR-80TP, which has a hand strap attached to it, greatly increases the size of grip making the camera easier to hold. The grip is also equipped with a simple tripod for micro photography and self-timer shots.



Camera Case EH8-L (LL)

The special camera case can hold the camera with the lens left on, ensuring that your camera is well protected.

- Case L: EF 35-80 mm f/4-5.6 II,
EF 35-105 mm f/4.5-5.6 USM
- Case LL: EF 28-80 mm f/3.5-5.6 II USM,
EF 80-200 mm f/4.5-5.6 USM

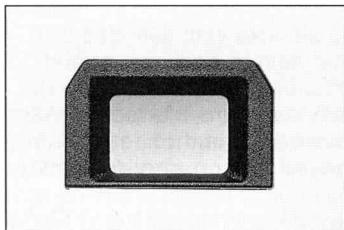

Dioptic Adjustment Lenses

The dioptic adjustment lenses E allow near or long-sighted people to take photographs without having to use their eyeglasses. While the camera itself has a -1 diopter, there are 10 interchangeable correction lenses available. Select the correct one for yourself by trying it out on the viewfinder.

- The numerical values printed on the dioptic lenses indicate the dioptic value when attached to the camera. This number does not indicate the dioptic value of the dioptic adjustment lens itself.

Keep your camera in top condition by following these suggestions for periodic cleaning. See the precautions on page 4 for other important information.

1. Cleaning the lens surface—

Blow off dust with a blower brush and gently wipe the lens surface with a piece of lens cleaning paper moistened with lens cleaner. Clean in a **spiral** motion from the center outwards.

2. Cleaning mirror and focusing screen—

Use a blower brush reserved for this purpose only. If more cleaning is necessary do not attempt to do it yourself. Take the camera to an authorized Canon service facility.

3. Cleaning the film chamber—

Use a blower brush to remove accumulated film dust particles that might scratch the film. Be careful not to touch the shutter curtain.

4. Cleaning the film pressure plate and film guide rails—

Lightly wipe the surface with a piece of lens cleaning paper moistened with lens cleaning fluid. Be careful not to touch the shutter curtain.

- Use of aerosol spray dust removers is not recommended.

1) LCD Information

The LCD panel uses liquid crystal to show exposure information. After about five years, the display may become difficult to read. If this occurs, have it replaced at an authorized Canon service facility. Replacement is at the owner's expense.

Liquid crystal may also respond relatively slowly in temperatures below 0°C. It may also darken in temperatures of around 60°C. The LCD panel will return when the temperature returns to normal.

2) When b_c Indicator Appears in LCD Panel

There are two situations in which the b_c indicator will appear in the LCD panel: (1) when the batteries are nearly exhausted or (2) when the camera's self-test process detects an internal malfunction. If the b_c indicator appears, perform the following operations:

1. Remove the batteries, wipe the battery terminals and reload them. Check the batteries again. If the **b_c** indicator still appears, replace the batteries with new ones.
2. Release the shutter once.
If the **b_c** indicator goes out, the problem is corrected and you can continue using the camera normally. If the **b_c** indicator does not stop, the camera needs to be examined by an authorized Canon service facility.

3) Lithium Battery Information

Always check the batteries at the following times:

1. When loading new batteries
2. After lengthy storage
3. If the shutter will not release
4. In cold weather
5. Before an important shooting assignment

Battery Use Information

- Wipe the battery terminals with a clean, dry cloth to ensure proper contact.
- The batteries may explode or cause burns if disassembled, recharged, shorted, exposed to high temperatures, or disposed of in fire. Be sure to observe all precautions indicated on the battery package. Always keep it out of the reach of children.
- Battery performance deteriorates slightly in temperatures below 0°C. Keep the camera and especially a spare battery close to your body or in an inside pocket to keep it warm until use.
- Remove the batteries if you do not expect to use the camera for more than three weeks.

4) Camera Operation with Low Batteries

Even if the **b_c** indicator appears in the LCD panel during battery check, exposure will be okay as long as the shutter releases. Film advance and rewind will be impaired by insufficient battery power. Please replace the batteries with new ones.

Table of Main Specifications

Type	35 mm focal plane shutter AF/AE single-lens reflex camera with built-in auto film winder (built-in flash provided on Rebel X S only).
Usable lenses	Canon EF lens series
Lens mount	Canon EF mount (electronic signal transfer system)
Viewfinder	90% vertical and horizontal coverage.
Magnification	× 0.7 (50 mm lens on infinity)
Standard diopter	-1 diopter (eyebond 18.5 mm)
Focussing screen	Complete matte screen with fixed, AF frame, partial metering mark.
Shooting modes	<ul style="list-style-type: none"> ① Manual ② Automatic depth-of-field AE ③ Aperture-priority AE ④ Shutter-priority AE ⑤ Program AE (with program shift) ⑥ Full auto ⑦ Programmed Image Control (four types) ⑧ Flash AE (A-TTL with the built-in flash or A-TTL or TTL program flash AE with a Speedlite)
Camera shake warning	Operates in full auto and in image zones. Shutter speed blinks as a warning when automatically-set shutter speed becomes 0~0.5 stops slower than "1/focal length of the lens in use".
Metering range	EV 2-20 (at normal temperature, 50mm f/1.4 lens at ISO 100)
Film speed setting	ISO 6-6400, automatically set according to DX code. (ISO 25-5000)
Exposure compensation	Manual setting +/- two stops in 1/2-stop increments. (Cannot also be used in image zone).
Multiple-exposures	Up to nine exposure can be preset. Automatically clears on completion.

AF control system	<ul style="list-style-type: none"> ① One-shot autofocus/stops on completion or release on completion possible. ② AI Focus/One-shot autofocus, switches automatically to AI Servo. ③ Manual/with the focus mode switch on M, manual focussing is possible.
AF working range	EV 1.5-18 (at ISO 100 standard chart)
§ AF auxiliary light	Automatically emitted.
Shutter	Vertical-travel, focal plane shutter with all speeds electronically controlled.
Shutter speed	1/2000-30 sec. and bulb. X-synchro on 1/90 sec. (1/2 increment settings possible).
Self-timer	Electronically controlled. (with about 10 second delay)
Film Loading	Automatic. After film loading and back cover closure, the film automatically winds to the end of the roll and stops.
Film Wind	Automatic film wind: <ul style="list-style-type: none"> ① Single shot. ② Continuous shooting (up to a maximum of about one frame per second).
Rewind	Automatic rewind. Rewind in mid roll possible.
§ Built-in flash	Retractable type TTL automatic flash housed in pentaprism. Bypass control system. <ul style="list-style-type: none"> ① Guide number /12 (ISO 100 m) ② Recycling time approx. 2 sec. ③ Flash coverage angle: cover the angle of view of a 28mm lens.
Flash contacts	X-sync contact, which connects directly to the accessory shoe.
Batteries	2 lithium CR123A/DL123A batteries
Battery capacity check	Can be checked by setting the command dial to any setting outside the special mode zones.
Size	145 (W) x 92 (H) x 61.9 (D) mm
Weight	About 315 g, or 350 g with the built-in flash. (Body only and excluding two CR123A/DL123A lithium batteries).

IV. OTHER INFORMATION

Lens		EF35 - 80 f/4 - 5.6 II	EF80 - 200 f/4.5 - 5.6 USM
Angle of View	Diagonal	63° - 30°	30° - 12°
	Vertical	38° - 17°	17° - 7°
	Horizontal	54° - 25°	25° - 10°
Optical Construction		8 elements in 8 groups	10 elements in 7 groups
Minimum aperture		22 - 32	22 - 27
Shooting distance		0.38 m - ∞	1.5 m - ∞
Maximum magnification		35 mm	80 mm
		0.12 (212 × 328 mm)	0.065 (366 × 546 mm)
		80 mm	200 mm
		0.25 (97 × 144 mm)	0.156 (153 × 226 mm)
Diameter and number of filters usable		52 mm, 1	52 mm, 1
Length × maximum diameter		61 × 65 mm	78.5 × 69 mm
Weight		170 g	260 g

- The specifications of this product as well as some external features are subject to change without notice. (All data based on Canon's Standard Test Method)